

6000K+ SERIES
Quick Start Guide

**Image shown here is indicative only. If there is any inconsistency between the image and the actual product you receive, the actual product will govern.*

Contents

Safety Warning 1

Connection 3

Maintenance 7

Safety Warning

Before operating, please read this manual thoroughly, and keep it for future reference. Images shown in this manual are indicative only. There may be differences between the pictures and the actual product.

Placement

- Do not place the unit on an unstable cart, stand, tripod, bracket, table, or shelf.
- Do not expose the unit to direct sunlight and other sources of heat.
- Do not put the unit near appliances that generate magnetic fields.
- Do not handle liquids near or on the unit.
- Never spill liquid of any kind into the unit.
- Do not put heavy objects on top of the unit.

Power Supply

- Check that the unit's operating voltage is identical with your local power supply.
- Please unplug the power supply and aerial plug when the weather is thunder-storm or lightning.
- Please unplug the power supply, when there is nobody at home or don't use it over a long period.
- Please keep the power cord from physical or mechanical damage.
- Please use exclusive power cord, don't modify or lengthen it.
- Please check and ensure AC source is connected with the ground.

LED Screen

- Never use any other hard or sharp object to replace the stylus.
- Unplug the power supply before cleaning.
- Clean the screen with a soft, dustless, and dry cloth.
- Never use water or the spray type detergent to clean the unit.
- For deep clean, contact an authorized service center.
- Please don't display the high brightness image on the screen for a long time.

Sight Distance

- The best distance between audience and screen is 3-4 times that of screen diagonal length.
- The best watching angle between audience and screen as top and bottom, or so inside 176°.

Temperature

- Do not place the unit near or over a radiator or a heater register.
- If your unit is suddenly moved from a cold to a warm place, unplug the power cord for at least two hours to let the moisture that may have formed inside the unit dry completely.
- Normal operating temperature is 0 ~ 40°C.

Humidity

Do not expose the unit to rain or place near water.

Ventilation

Don't cover the ventilation.

Ensure that the unit has enough space for ventilation around: left, right and back >10cm, top > 20cm.

Earphone

Listening to loud noises for a long period will affect your hearing.

Before using earphones, please turn down the volume in advance.

Standby

Pressing the standby key will cause the panel to enter standby mode.

Pressing the standby key will not cause the panel to turn off.

Battery

Please make sure the battery gets proper disposal or recycle after using.

To avoid danger, do not let children touch the battery.

Notes for Cleaning

There are ventilation holes on the back cover, do not spray with water.

Power Switch Status Signs

“I” means power on, “O” means power off.

Notes for Maintenance

This machine can only be maintained by a certified engineer.



Disclaimer

When any of the following cases occurs, the company does not guarantee the liability of free maintenance.

- a. Product damages caused by violating the user guidance.
- b. Product damages to the hardware by improper assembly.
- c. Product damages caused by unauthorized modification or maintenance.
- d. Product damages caused by use in an unpermitted environment.
- e. Product damages caused by abnormal external force.
- f. Product damages caused by natural disasters or other force of nature.
- g. Removed or damaged disassembly tabs.
- h. Unable to provide an effective purchase certificate.

Power

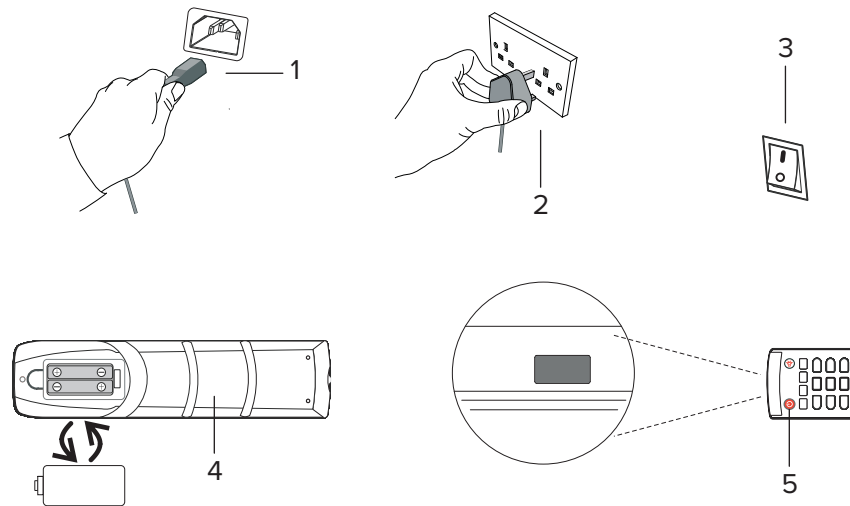

Powering the machine on/off

1. Plug the power cable into the power socket of the unit.
2. Plug the power cable into the power supply.
3. Press the on/of button to startup the unit. “I” means power on, “O” means power off.
4. Remove the cover on the rear of the remote control as shown, insert two AAA equivalent batteries.
5. Press the POWER button on the remote control, if the indicator at the right bottom shows blue, the unit has been powered on.

Note: Please use the INPUT button on the remote control or use the touch menu to enter the built-in computer’s PC channel. (to use the touch menu please refer to the user manual.)

Caution

1. Don’t use rechargeable battery, such as the nickel-cadmium cell. It is different from shape and function, it is hard to ensure operation accuracy. Please dispose of used batteries in an environmentally friendly way.
2. Press the power button on the remote control or press the power button for three seconds on the keypad and wait for the unit to shut down. Only after the indicator light turns red, turn off the power switch and disconnect the main power. Avoid disconnecting the power switch or main power when the unit is in normally open mode or the indicator light is blue. Directly powering the unit off may cause damage to the hardware.
3. This device comes standard with a power cord for the device use only, please do not use it for other devices.

External Touch Connection

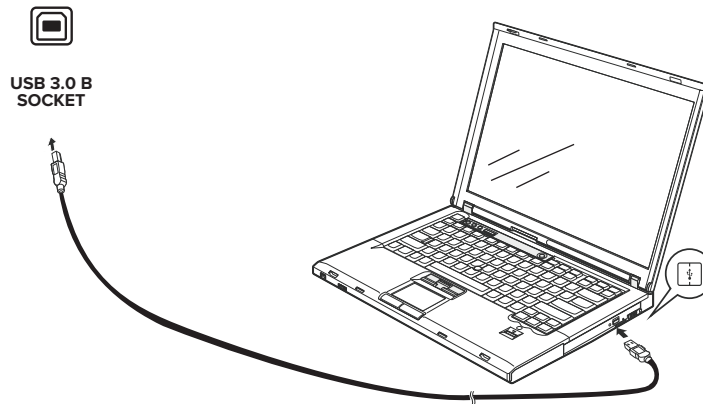

Touch Screen Compatability

Use the USB touch cable to connect an external computer to the interactive Panel's corresponding interface as shown. After switching the computer's image to the plate output, it can achieve the touch function. Utilizing USB Type-C will allow for audio, video, and touch all in one cable connection.

Key & Port Description

1.  : Power on/off button
Press quickly to go into energy-saving mode. Press and hold for three seconds to initiate shutdown mode.
2. USB : USB interface of Android & PC system

Connection of Common Ports

For the number and type of the equipment port, please refer to the actual product. The input source as follow is used just for example.

1. Audio Out

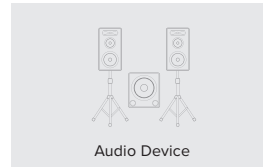
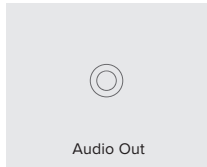

2. LAN

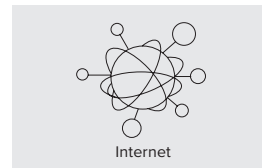
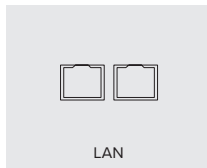

3. HDMI Signal Input



4. HDMI Signal Output

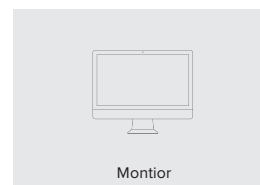

5. RS232 Connection

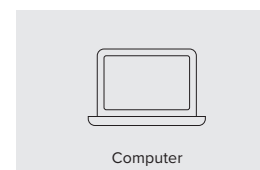
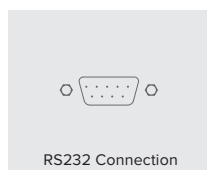

6. VGA (Audio In)

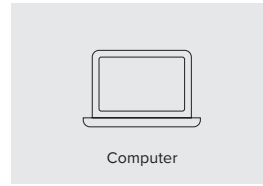
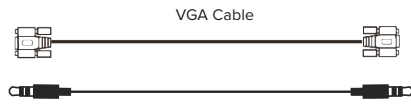
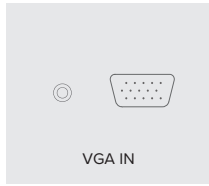

7. USB

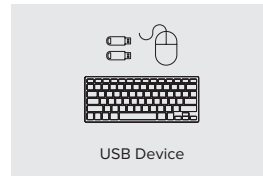

Maintenance

Proper maintenance can prevent many failures early on in the product's life. Regular careful cleaning can keep the unit appearing brand new. Please unplug the power line before cleaning and maintenance to prevent electric shock.

Clean Screen

1. Choose an approved electronic cleaning solution. Reference our FAQ on our support site.
2. Saturate a piece of soft cloth in the mixture mentioned above.
3. Take out the cloth and wring it to half dry and then clean the screen.
4. Repeat the procedures above. Attention: do not drop water into the unit while cleaning.

Clean Face Frame

Please choose a dry, soft, and non-fluff cloth to clean the face frame.

Extended Storage

If the machine is not used for a long time, please unplug to prevent lightning or other power surges from damaging the unit.

